

YDS-CMFL1812C6-OS12D40 V1.0**11.3MP OmniVision OS12D40 Fixed Focus Camera Module**

Front View

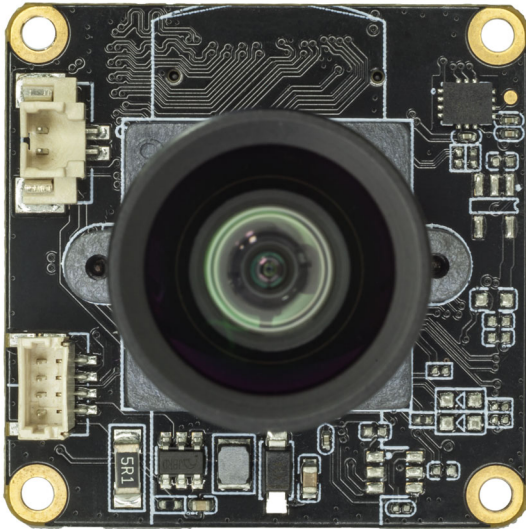
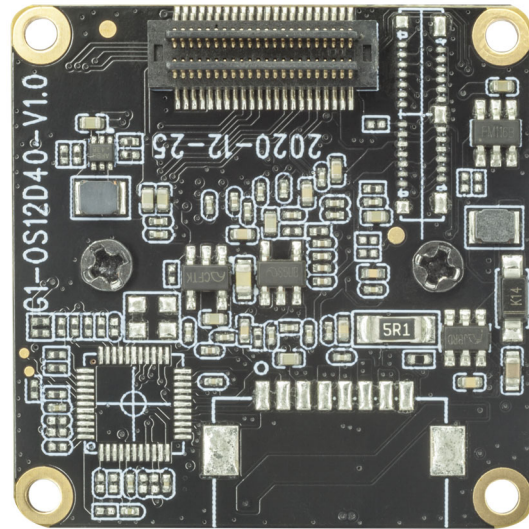

Back View

Overview

The OmniVision OS12D40 color image sensor used in the YDS-CMFL1812C6-OS12D40 V1.0 camera module is a high-performance CMOS 1/2.49" image sensor that can provide 11.3 megapixels (4512x2512) image signals at up to 60FPS, with a pixel size of 1.404um x 1.404um.

When used with the master board, it can support shooting 11MP high-definition images, up to 4K@60FPS (differential), and 4K@30FPS video shooting.

This camera uses board-to-board socket connection. It supports multi-axis EIS anti-shake image stabilization function. The board frame size is 32*32mm, and the size from the top of the module lens to the PCB board surface is 28.3mm.



YDS-CMFL1812C6-OS12D40 V1.0

11.3MP OmniVision OS12D40 Fixed Focus Camera Module

Specifications

Model No.	YDS-CMFL1812C6-OS12D40 V1.0
Image Sensor	OS12D40
Image Sensor Type	CMOS
Effective Pixels	11.3 Megapixels
Sensor Size	1/2.49"
Pixel Size	1.404 um x 1.404 um
Video Frame Rate	4K@24/25/30/FPS, 4K@48/50/60FPS (Differential) 2.7K@24/25/30/48/50/60FPS 1080P@24/25/30/48/50/60/120FPS 720P@24/25/30/48/50/60/120/240FPS
Video Slow Motion	OFF, 4K2X, 1080P4X, 720P8X
Photo Resolution (with Master Board)	20MP (5200x3900) (Differential) 13MP (4160x3120) (Differential) 12MP (4000x3000) 10MP (3648x2736) 8MP (3264x2448) 5MP (2592x1944) 3MP (2048x1536) 2MP (1920x1080)
Operating Temperature	-10°C to +60°C
Storage Temperature	-20°C to +80°C
Humidity	20% to 80%
PCB Dimensions	32 x 32 mm
Module Size	33 x 32 x 28.3 mm
PCB Screw Hole Spacing	28 x 28 mm
PCB Screw Hole Diameter	2 mm
Lens Mount Screw Diameter	1.6 mm

YDS-CMFL1812C6-OS12D40 V1.0

11.3MP OmniVision OS12D40 Fixed Focus Camera Module

Lens Specifications

Lens Model No.	L1812C6
EFL (Focal Length)	3.24 mm
TTL (Total Length)	22.5 mm
F. No.	2.70
Lens Construction	4G2P + IR
Diagonal View Angle (DFOV)	95.6° (DFOV) (y' = 3.62 mm)
Horizontal View Angle (HFOV)	87.6° (HFOV) (y' = 3.17 mm)
Vertical View Angle (VFOV)	56.4° (VFOV) (y' = 1.76 mm)
Chief-Ray Angle	<13.8°
Distortion	<0.5%
Relative Illumination	>67%
Lens Operating Temperature	-40°C to +85°C
Lens Storage Temperature	-40°C to +95°C

Lens Drawing

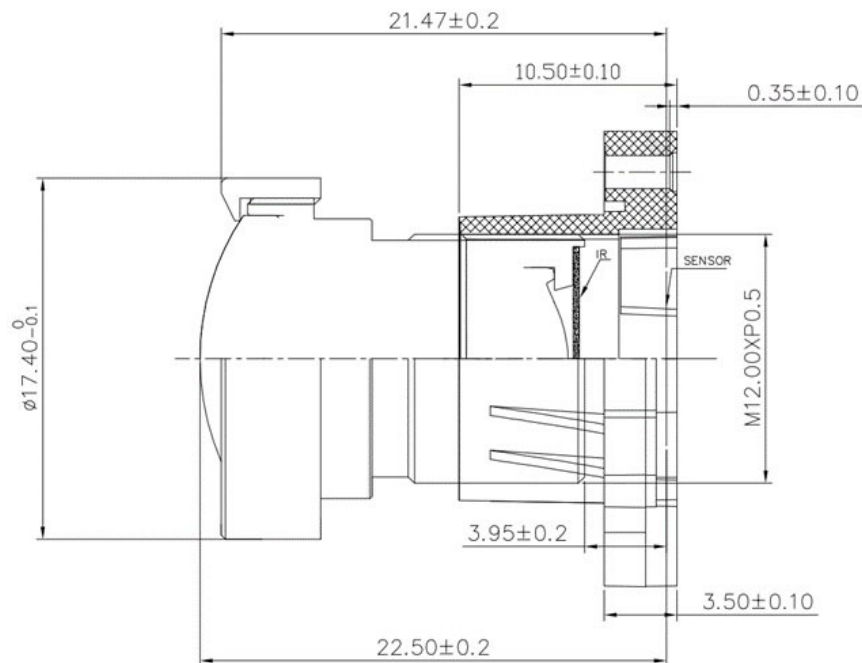

YDS-CMFL1812C6-OS12D40 V1.0

11.3MP OmniVision OS12D40 Fixed Focus Camera Module

陀螺仪，支持EIS防抖

EIS Stabilization

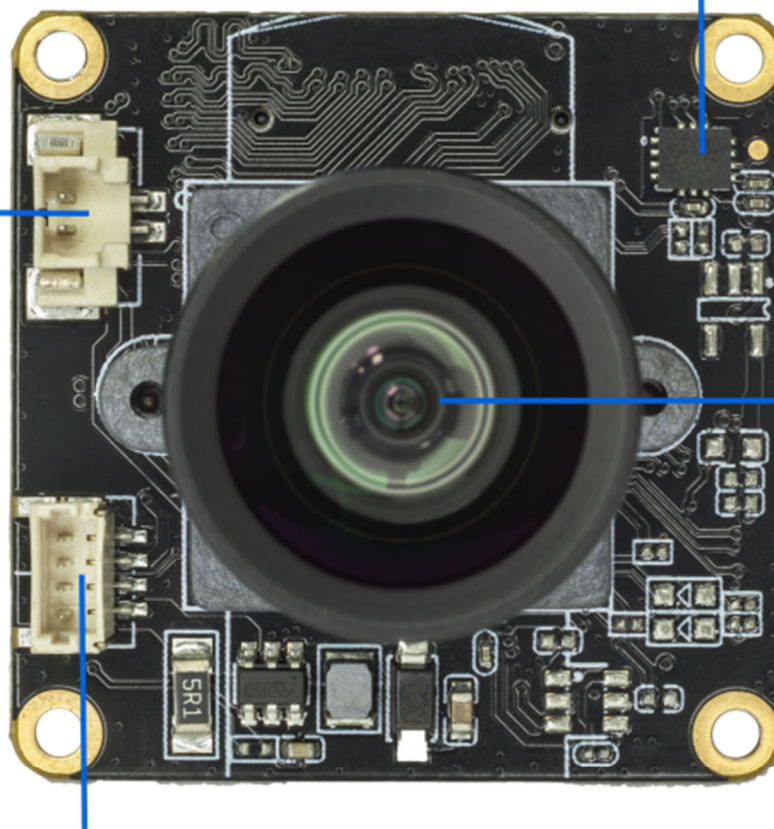
IR-CUT INTERFACE
滤光片切换器接口

L1816C2镜头模组

两组LED补光灯接口

LEDS * 2 INTERFACE



YDS-CMFL1812C6-OS12D40 V1.0

11.3MP OmniVision OS12D40 Fixed Focus Camera Module

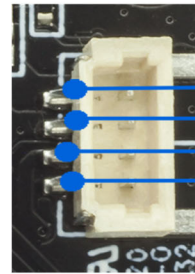
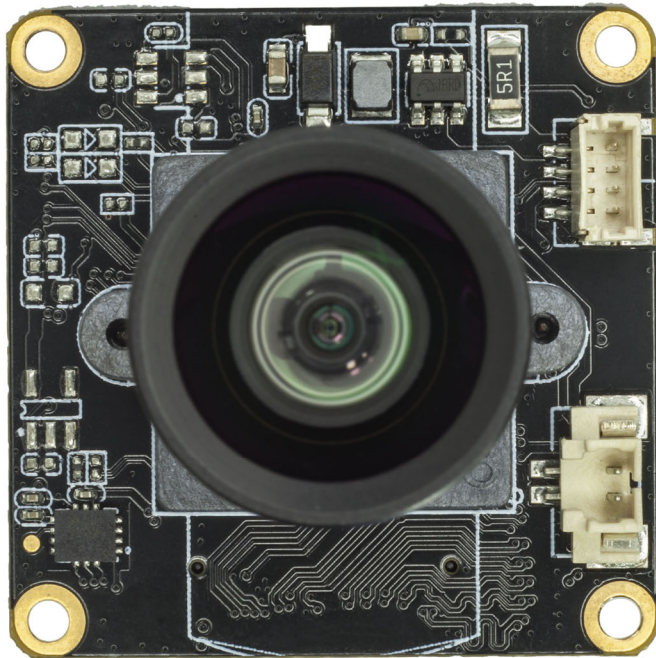

LED B -
LED B +
LED A -
LED A +

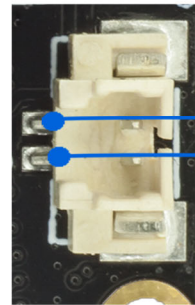

IR-CUT -
IR-CUT +

The two groups of fill light interfaces support the expansion of infrared lights and white light boards to provide fill light for the device. Note: The IR-Cut filter switch interface is used by lenses with filters, but this camera module does not support this function.



YDS-CMFL1812C6-OS12D40 V1.0

11.3MP OmniVision OS12D40 Fixed Focus Camera Module

通过板对板连接器支持 Sensor、EIS、IR-CUT、LED等 Connect Sensor、EIS、IR-CUT、Led

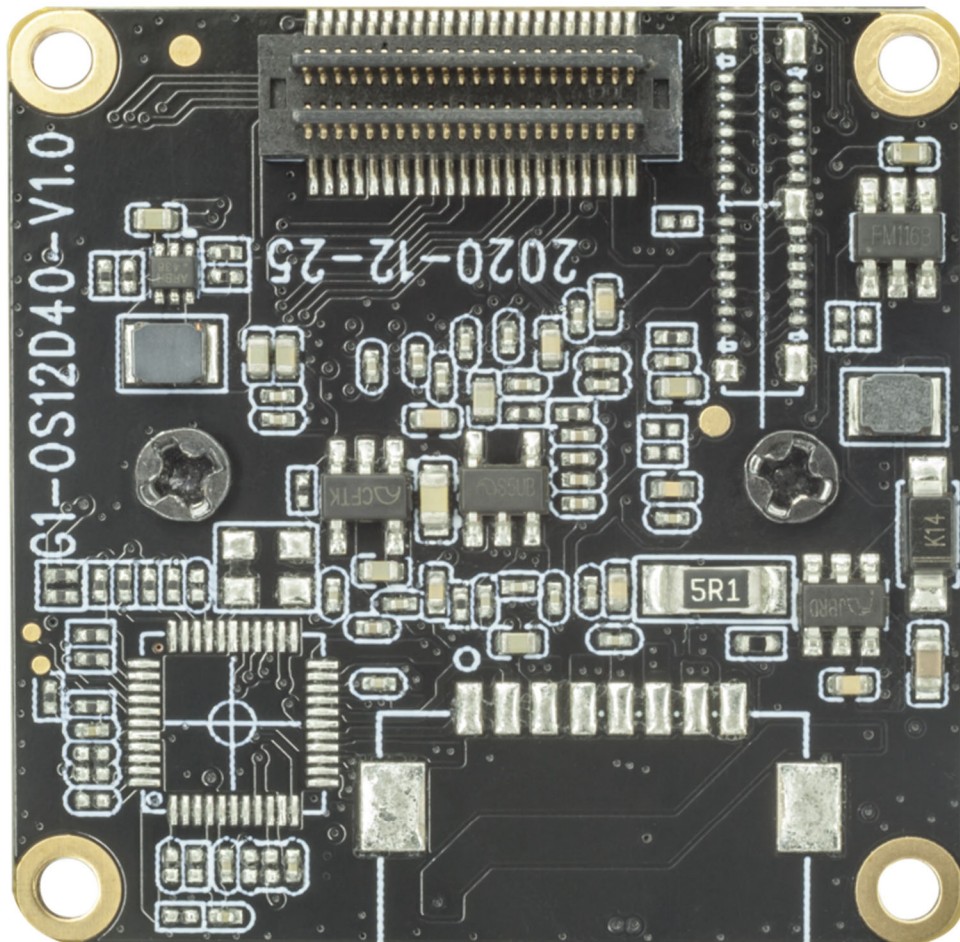

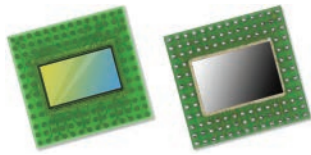

OS12D40 11.3-megapixel product brief



available in
a lead-free
package

Security Image Sensor Provides Industry-High 11.3MP Resolution for 4K2K With Electronic Image Stabilization and Best in Class HDR for 1080p Video

OmniVision's OS12D40 is a 1.4 micron pixel, 11.3MP image sensor that offers the unprecedented combination of a large 1/2.49" optical format, on-chip remosaic (4-cell to Bayer) color converter and on-chip high dynamic range (HDR) processing. It is the industry's only security sensor with 3-exposure, 4-cell HDR capability to provide larger-pixel low light performance with the best artifact elimination for moving objects. When in full-HD 1080p mode, this sensor's 3-exposure HDR with on-chip combination and tone mapping provides best in class video captures. This is superior to the competing method, known as staggered HDR, which relies on additional passes that introduce motion artifacts, especially in low light.

Integrated selective conversion gain technology allows the pixel conversion gain to be dynamically switched between low and high, depending on the scene being captured. In combination with its other features—including PureCel[®]Plus-S stacked pixel technology for reduced cross talk and maximum quantum efficiency in low light—this image sensor enables mass market security cameras to capture the industry's highest quality video and ultra wide angle photos.

The OS12D40's fast mode switch allows security operators or AI-enabled surveillance systems to seamlessly switch to 4K2K mode when a specific threat is identified for closer inspection, such as a potential intruder or unauthorized vehicle. This sensor's best in class 11.3MP resolution provides the extra pixels needed for 4K2K images with electronic image stabilization (EIS), to ensure that details can be clearly identified.

The OS12D40 is a native 16:9 aspect ratio image sensor that uses a 4-cell color filter pattern. It has an on-chip 4-cell to Bayer remosaic converter, in order to provide 4K video at 60 fps with 20% additional pixels for EIS. In a 4-cell binned mode, it can output an impressive 2.8MP/1080p resolution with 20% additional pixels for EIS video and images at four times the sensitivity. This sensor also supports both CPHY and DPHY interfaces.

Find out more at www.ovt.com.



OmniVision

Applications

- Security Cameras
- PC Multimedia
- Machine Vision

Product Features

- automatic black level calibration (ABLC)
- programmable controls for:
 - frame rate
 - mirror and flip
 - binning
 - cropping
 - windowing
- support for dynamic defect pixel cancellation (DPC)
- supports output formats: 10-bit RGB 4-cell pattern Bayer RAW
- supports horizontal and vertical subsampling
- supports typical images sizes:
 - 4512 x 2512
 - 3840 x 2160
 - 2256 x 1256
 - 1920 x 1080
 - 1280 x 720
- standard serial SCCB interface
- up to 4-lane MIPI TX interface with speed up to 2.5 Gbps/lane
- embedded 8k bits of one-time programmable (OTP) memory (4k bits reserved for customer use)
- 2/3 trio C-PHY interface, up to 1.6 Gbps/trio
- 4-cell support:
 - 4-cell binning
 - 4-cell full
- on-chip 4-cell to Bayer converter
- three on-chip phase lock loops (PLLs)
- sequential multi-frame HDR
- 2.8MP 10-bit 3-exposure 4C HDR output after tone mapping
- programmable I/O drive capability
- built-in temperature sensor
- typical module size: 8.5 x 8.5 x -5.1 mm

OS12D40



Ordering Information

- OS12D40-J08A-Z (color, lead-free)
108-pin fan-out package

Technical Specifications

- active array size: 4512 x 2512
- maximum image transfer rate:
 - 4512 x 2512: 60 fps
- power supply:
 - core: 1.1V
 - analog: 2.8V
 - I/O: 1.8V
- power requirements:
 - active: 505 mW
 - standby: <10 μW
- temperature range:
 - operating: -30°C to +85°C junction temperature
 - stable: 0°C to +60°C junction temperature
- output formats:
 - 10-bit RGB 4-cell pattern Bayer RAW
- lens size: 1/2.49"
- lens chief ray angle: 8.7° linear
- scan mode: progressive
- pixel size: 1.404 μm x 1.404 μm
- image area: 6365.736 μm x 3554.928 μm

Functional Block Diagram

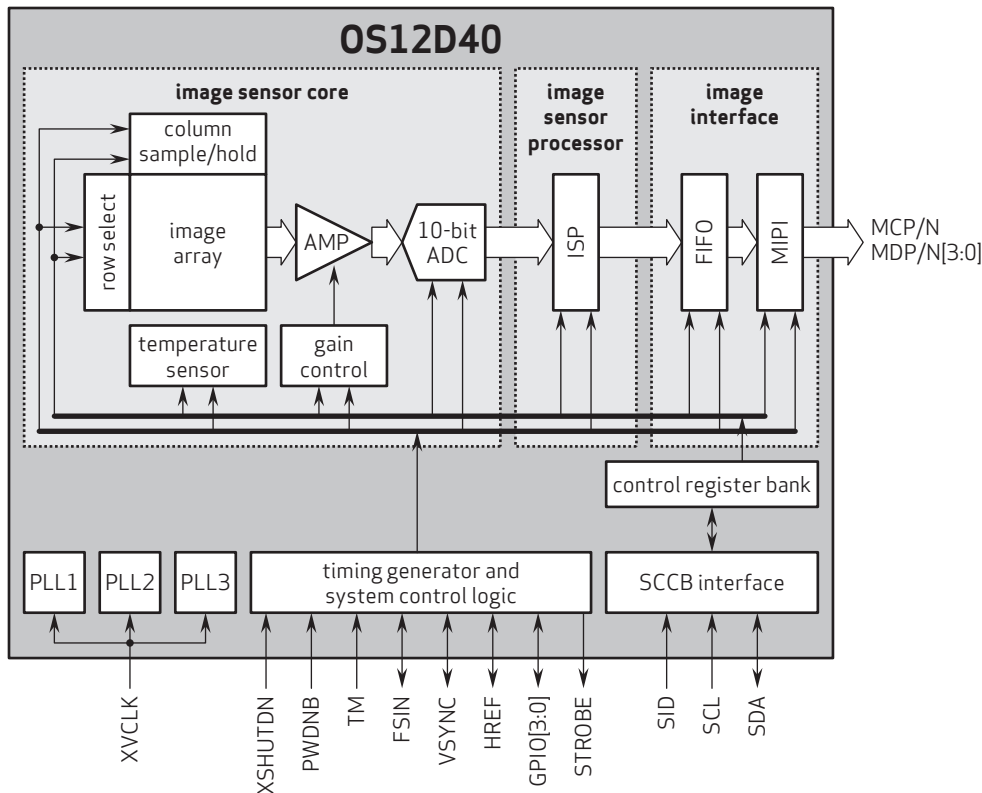

4275 Burton Drive
Santa Clara, CA 95054
USA

Tel: +1 408 567 3000
Fax: +1 408 567 3001
www.ovt.com

OmniVision reserves the right to make changes to their products or to discontinue any product or service without further notice. OmniVision, the OmniVision logo and PureCel are registered trademarks of OmniVision Technologies, Inc. All other trademarks are the property of their respective owners.



OmniVision

Cameras Applications



Automotive Driver Pilot



Live Streaming



Video Conference



Eye Tracker Biometric Detection

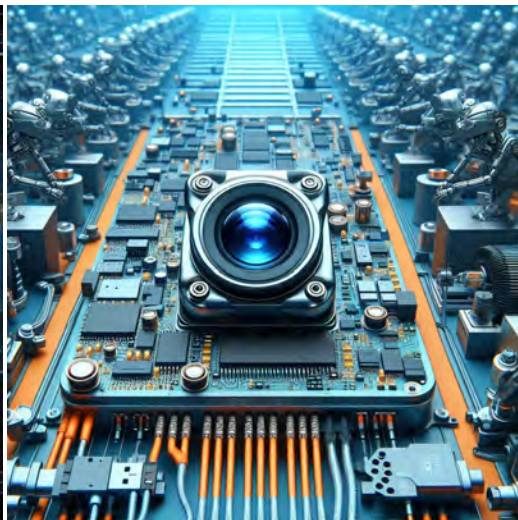

Machine Vision



Agricultural Monitor



Night Vision Security



Drone and Sports Eagle Eyes



Interactive Pet Camera



YDS CAMERA MODULE

your best camera partner

Camera Module Pinout Definition Reference Chart

OmniVision	Sony	Samsung	On-Semi	Aptina	Himax	GalaxyCore	PixArt	SmartSens	Sensors
Pin Signal		Description							
DGND GND		ground for digital circuit							
AGND		ground for analog circuit							
PCLK DCK		DVP PCLK output							
XCLR PWDN XSHUTDOWN STANDBY		power down active high with internal pull-down resistor							
MCLK XVCLK XCLK INCK		system input clock							
RESET RST		reset active low with internal pull-up resistor							
NC NULL		no connect							
SDA SIO_D SIOD		SCCB data							
SCL SIO_C SIOC		SCCB input clock							
VSYNC XVS FSYNC		DVP VSYNC output							
HREF XHS		DVP HREF output							
DOVDD		power for I/O circuit							
AFVDD		power for VCM circuit							
AVDD		power for analog circuit							
DVDD		power for digital circuit							
STROBE FSTROBE		strobe output							
FSIN		synchronize the VSYNC signal from the other sensor							
SID		SCCB last bit ID input							
ILPWM		mechanical shutter output indicator							
FREQ		frame exposure / mechanical shutter							
GPIO		general purpose inputs							
SLASEL		I2C slave address select							
AFEN		CEN chip enable active high on VCM driver IC							
MIPI Interface									
MDN0 DN0 MD0N DATA_N DMO1N		MIPI 1st data lane negative output							
MDP0 DP0 MD0P DATA_P DMO1P		MIPI 1st data lane positive output							
MDN1 DN1 MD1N DATA2_N DMO2N		MIPI 2nd data lane negative output							
MDP1 DP1 MD1P DATA2_P DMO2P		MIPI 2nd data lane positive output							
MDN2 DN2 MD2N DATA3_N DMO3N		MIPI 3rd data lane negative output							
MDP2 DP2 MD2P DATA3_P DMO3P		MIPI 3rd data lane positive output							
MDN3 DN3 MD3N DATA4_N DMO4N		MIPI 4th data lane negative output							
MDP3 DP3 MD3P DATA4_P DMO4P		MIPI 4th data lane positive output							
MCN CLKN CLK_N DCKN		MIPI clock negative output							
MCP CLKP MCP CLK_P DCKN		MIPI clock positive output							
DVP Parallel Interface									
D0 DO0 Y0		DVP data output port 0							
D1 DO1 Y1		DVP data output port 1							
D2 DO2 Y2		DVP data output port 2							
D3 DO3 Y3		DVP data output port 3							
D4 DO4 Y4		DVP data output port 4							
D5 DO5 Y5		DVP data output port 5							
D6 DO6 Y6		DVP data output port 6							
D7 DO7 Y7		DVP data output port 7							
D8 DO8 Y8		DVP data output port 8							
D9 DO9 Y9		DVP data output port 9							
D10 DO10 Y10		DVP data output port 10							
D11 DO11 Y11		DVP data output port 11							

www.YDSCAM.com sales@ydscam.com Phone (WeChat, QQ): (+86) 177 2732 6718

All rights reserved @ YingDeShun Co. Ltd. Specifications subject to change without notice.

Camera Reliability Test

Reliability Inspection Item		Testing Method	Acceptance Criteria	
Category	Item			
Environmental	Storage Temperature	High 60°C 96 Hours	Temperature Chamber	No Abnormal Situation
		Low -20°C 96 Hours	Temperature Chamber	No Abnormal Situation
	Operation Temperature	High 60°C 24 Hours	Temperature Chamber	No Abnormal Situation
		Low -20°C 24 Hours	Temperature Chamber	No Abnormal Situation
	Humidity	60°C 80% 24 Hours	Temperature Chamber	No Abnormal Situation
	Thermal Shock	High 60°C 0.5 Hours Low -20°C 0.5 Hours Cycling in 24 Hours	Temperature Chamber	No Abnormal Situation
Physical	Drop Test (Free Falling)	Without Package 60cm	10 Times on Wood Floor	Electrically Functional
		With Package 60cm	10 Times on Wood Floor	Electrically Functional
	Vibration Test	50Hz X-Axis 2mm 30min	Vibration Table	Electrically Functional
		50Hz Y-Axis 2mm 30min	Vibration Table	Electrically Functional
		50Hz Z-Axis 2mm 30min	Vibration Table	Electrically Functional
	Cable Tensile Strength Test	Loading Weight 4 kg 60 Seconds Cycling in 24 Hours	Tensile Testing Machine	Electrically Functional
Electrical	ESD Test	Contact Discharge 2 KV	ESD Testing Machine	Electrically Functional
		Air Discharge 4 KV	ESD Testing Machine	Electrically Functional
	Aging Test	On/Off 30 Seconds Cycling in 24 Hours	Power Switch	Electrically Functional
	USB Connector	On/Off 250 Times	Plug and Unplug	Electrically Functional



Camera Inspection Standard

Inspection Item		Inspection Method	Standard of Inspection		
Category	Item				
Appearance	FPC/ PCB	Color	The Naked Eye	Major Difference is Not Allowed.	
		Be Torn/Chopped	The Naked Eye	Copper Crack Exposure is Not Allowed.	
		Marking	The Naked Eye	Clear, Recognizable (Within 30cm Distance)	
	Holder	Scratches	The Naked Eye	The Inside Crack Exposure is Not Allowed	
		Gap	The Naked Eye	Meet the Height Standard	
		Screw	The Naked Eye	Make Sure Screws Are Presented (If Any)	
		Damage	The Naked Eye	The Inside Crack Exposure is Not Allowed	
	Lens	Scratch	The Naked Eye	No Effect On Resolution Standard	
		Contamination	The Naked Eye	No Effect On Resolution Standard	
		Oil Film	The Naked Eye	No Effect On Resolution Standard	
		Cover Tape	The Naked Eye	No Issue On Appearance.	
	Function	Image	No Communication	Test Board	Not Allowed
			Bright Pixel	Black Board	Not Allowed In the Image Center
Dark Pixel			White board	Not Allowed In the Image Center	
Blurry			The Naked Eye	Not Allowed	
No Image			The Naked Eye	Not Allowed	
Vertical Line			The Naked Eye	Not Allowed	
Horizontal Line			The Naked Eye	Not Allowed	
Light Leakage			The Naked Eye	Not Allowed	
Blinking Image			The Naked Eye	Not Allowed	
Bruise			Inspection Jig	Not Allowed	
Resolution			Chart	Follows Outgoing Inspection Chart Standard	
Color			The Naked Eye	No Issue	
Noise			The Naked Eye	Not Allowed	
Corner Dark			The Naked Eye	Less Than 100px By 100px	
Color Resolution			The Naked Eye	No Issue	
Dimension	Height	The Naked Eye	Follows Approval Data Sheet		
	Width	The Naked Eye	Follows Approval Data Sheet		
	Length	The Naked Eye	Follows Approval Data Sheet		
	Overall	The Naked Eye	Follows Approval Data Sheet		

YDSCAM Package Solutions

YDS Camera Module



Complete with Lens Protection Film



Tray with Grid and Space



Place Cameras on the Tray



YDSCAM Package Solutions

Full Tray of Cameras

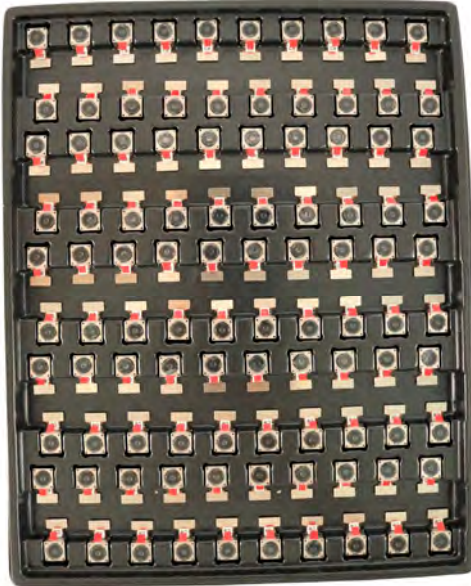

Cover Tray with Lid

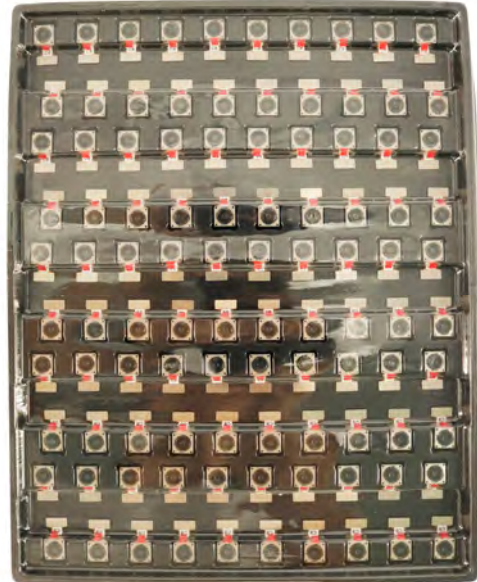

Place Tray into Anti-Static Bag



Vacuum the Anti-Static Bag



YDSCAM Package Solutions

Sealed Vacuum Anti-Static Bag with Labels

1. Model and Description 2. Quantity 3. Manufacturing Date Code 4. Caution



YDSCAM Package Solutions

Place Foam Sheets Between Tray Bags



Foam Sheets are Larger Than Trays



Place Foam Sheets and Trays into Box



Foam Sheets are Tightly Fitting in Box



Seal the Carbon Box



Label the Carbon Shipping Box



YDSCAM Package Solutions

USB Camera Module

Complete with Lens Protection Film



Place Camera Sample into Anti-Static Bag

Place USB Cameras into Tray



Seal the Tray with Anti-Static Bag

Label the Carbon Shipping Box



YDSCAM Package Solutions

Place Camera Sample into Anti-Static Bag



Place Connectors into Anti-Static Bag



Label the Sample Bags



Place Connectors into Reel



Place Samples into the Carbon Box



Place Connectors into the Carbon Box





YDS CAMERA MODULE

your best camera partner

Company YDSCAM

YingDeShun Co. Ltd. (YDS) was established in 2017, a next-generation technology driven manufacturer specialized in research, design, and produce of audio and video products. YDS is occupying 20,000 square feet automated plants with 100 employees of annual throughput 30,000,000 units cameras.

YDS provides OEM, ODM design, contract manufacturing, and builds the camera products. You may provide the requirements to us, even with a hand draft, our sales and engineering work together to meet your needs. We consider ourselves your last-term partner in developing practical and innovative solutions.

Our team covers everything from initial concept development to mass produced product. YDS specializes in customized camera design, raw material, electronic engineering, firmware/software development, product testing, and packing design. Our experienced strategic supply systems offer a robust and dependable manufacturing capacity for orders of various sizes.



Limited Warranty

YDS provides the following limited warranty if you purchased the Product(s) directly from YDS company or from YDS's website www.YDSCAM.com. Product(s) purchased from other sellers or sources are not covered by this Limited Warranty. YDS guarantees that the Product(s) will be free from defects in materials and workmanship under normal use for a period of one (1) year from the date you receive the product ("Warranty Period").

For all Product(s) that contain or develop material defects in materials or workmanship during the Warranty Period, YDS will, at its sole option, either: (i) repair the Product(s); (ii) replace the Product(s) with a new or refurbished Product(s) (replacement Product(s) being of identical model or functional equivalent); or (iii) provide you a refund of the price you paid for the Product(s).

This Limited Warranty of YDS is solely limited to repair and/or replacement on the terms set forth above. YDS is not reliable or responsible for any subsequent events.



www.YDSCAM.com sales@ydscam.com Phone (WeChat, QQ): (+86) 177 2732 6718

All rights reserved @ YingDeShun Co. Ltd. Specifications subject to change without notice.



YDS CAMERA MODULE

your best camera partner

YDS Strength

Powerful Factory



Professional Service



Promised Delivery



www.YDSCAM.com sales@ydscam.com Phone (WeChat, QQ): (+86) 177 2732 6718

All rights reserved @ YingDeShun Co. Ltd. Specifications subject to change without notice.